

## ACE-L™

**Patent Pending**



**Amphenol Fiber Systems International (AFSI) manufactures a complete line of next generation fiber optic termini that are used in a wide variety of connectors for harsh environment applications.**

**Featuring an original *positive-lock* design, AFSI's ACE-L™ (\*patent pending\*) connector is well equipped to handle your high vibration, temperature, and harsh environment requirements while delivering excellent optical performance.**

### Features & Benefits:

- Positive Lock
- Sealed
- Multiple Keys
- Small form factor
- Pull-Proof design
- Metal construction
- Angle Polish Capable
- Pencil-tip ferrules for faster polishing

### Specs:

- Temp: -65°C to 200°C+
- Vibration: up to 300Grms
- Mating Cycles: 500+ Cycles



**Patent Pending**

**Patent Pending**

**Amphenol Fiber Systems International, Inc. | 1300 Central Expressway N, Suite 100 Allen, TX 75013**  
Phone: (214) 547-2400 | Email: [sales@fibersystems.com](mailto:sales@fibersystems.com) | Website: [www.fibersystems.com](http://www.fibersystems.com)

Amphenol Fiber Systems International (AFSI), a division of Amphenol Military & Aerospace Operations (AMAO), is the largest manufacturer of harsh environment fiber optic cable assemblies & connectors in the world. Visit AMAO at [amphenolmao.com](http://amphenolmao.com).

# ACE-L™

Patent Pending

# Amphenol FSI

## Product Drawings:

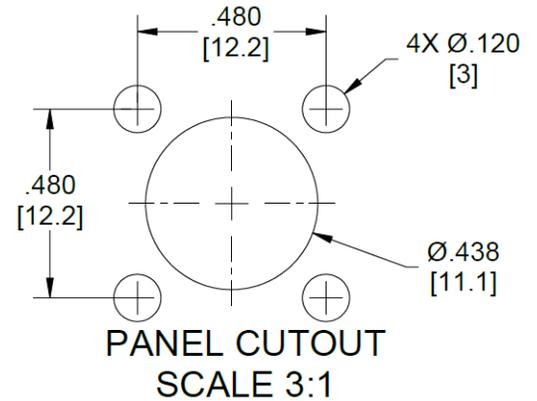
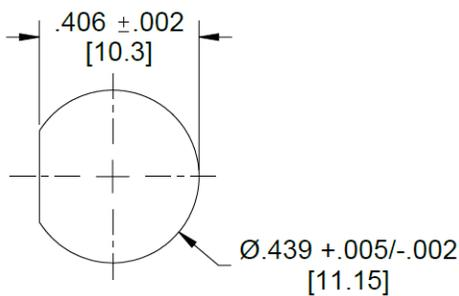
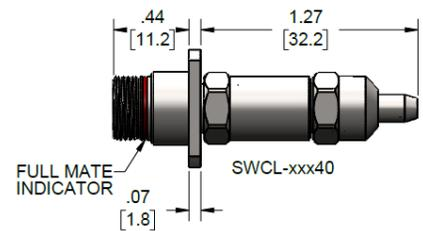
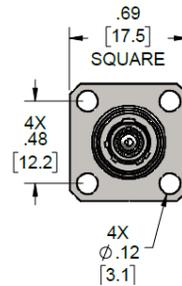
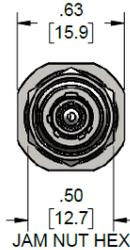
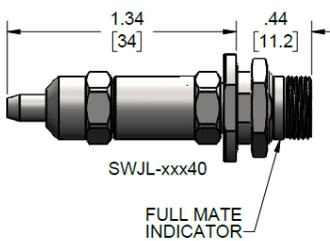
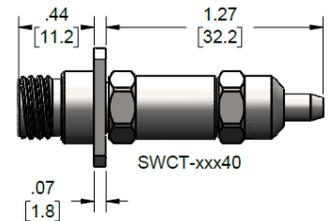
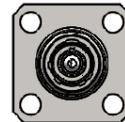
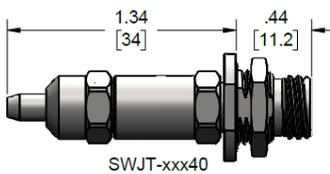
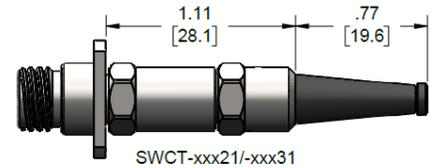
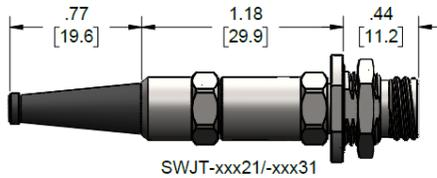
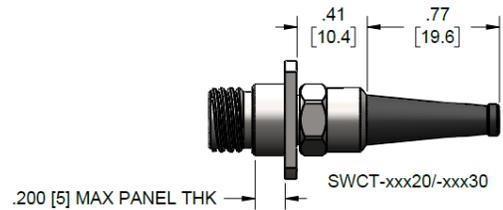
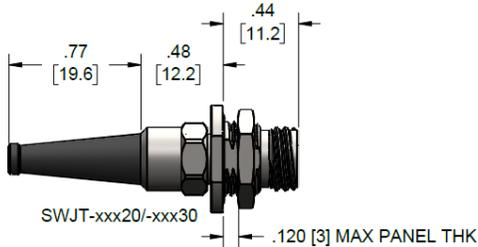

Patent Pending

Patent Pending

Amphenol Fiber Systems International, Inc. | 1300 Central Expressway N, Suite 100 Allen, TX 75013  
Phone: (214) 547-2400 | Email: sales@fibersystems.com | Website: www.fibersystems.com

Amphenol Fiber Systems International (AFSI), a division of Amphenol Military & Aerospace Operations (AMAO), is the largest manufacturer of harsh environment fiber optic cable assemblies & connectors in the world. Visit AMAO at amphenolmao.com.

# ACE-L™

Patent Pending

# Amphenol FSI

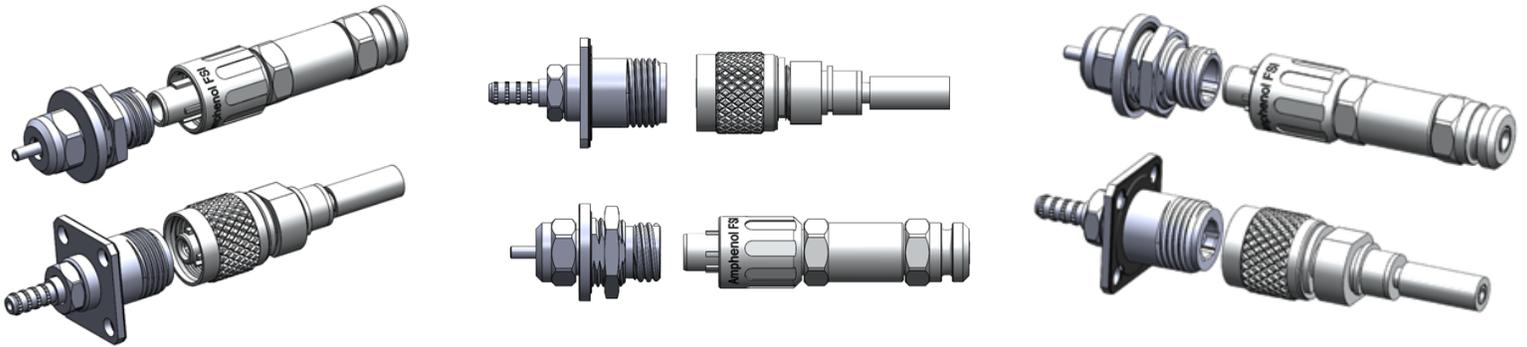

## Product Drawings:

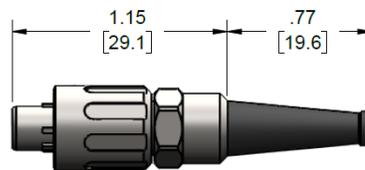

SWPT-xxx20/-xxx30

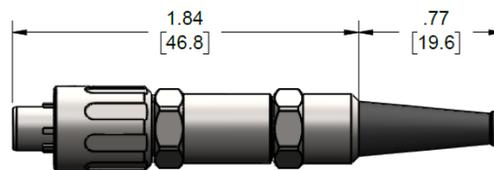

SWPT-xxx21/-xxx31

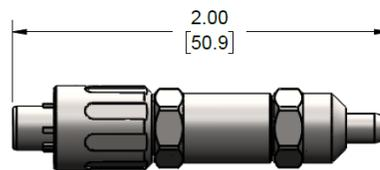
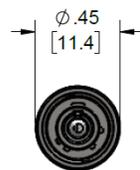

SWPT-xxx40

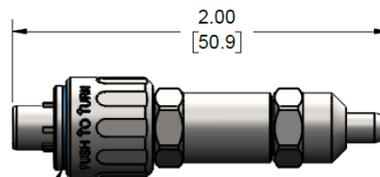
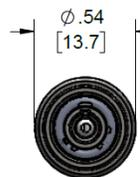

SWPL-xxx40

POSITIVE LOCK  
INDICATOR

Patent Pending

Patent Pending

Amphenol Fiber Systems International, Inc. | 1300 Central Expressway N, Suite 100 Allen, TX 75013

Phone: (214) 547-2400 | Email: sales@fibersystems.com | Website: www.fibersystems.com

Amphenol Fiber Systems International (AFSI), a division of Amphenol Military & Aerospace Operations (AMAO), is the largest manufacturer of harsh environment fiber optic cable assemblies & connectors in the world. Visit AMAO at amphenolmao.com.

## ACE-L™

**Patent Pending**

### Part Numbers:

SW - - - -

CONNECTOR

- PT - PLUG
- JT - RECEPTACLE, JAM NUT
- CT - RECEPTACLE, FLANGE

- PL - LOCKING PLUG
- JL - LOCKING RECEPTACLE, JAM NUT
- CL - LOCKING RECEPTACLE, FLANGE

MATERIAL

- S - 303 STAINLESS W/ SILICONE SEALS
- E - 303 STAINLESS W/ EPDM SEALS

CONNECTOR KEY

- 1-5 - KEY 1 THRU KEY 5
- 6 - UNIVERSAL KEY

FIBER

- A - SM/APC
- B - SM 125.5µm
- C - MM 126µm

CABLE

- 20 - 2mm W/ CRIMP & BOOT
- 21 - 2mm W/ PULL-PROOF BACKSHELL & BOOT
- 30 - 3mm W/ CRIMP & BOOT
- 31 - 3mm W/ PULL-PROOF BACKSHELL & BOOT
- 40 - 1.2mm CONDUIT W/ BACKSHELL



### How to Order:

For more information on how to order or to obtain a price quote on cable assemblies using our ACE-L™ connector (*\*patent pending\**) or any of our other products, please call us at 800-472-4225. For international calls please dial 214-547-2400 or e-mail us at [info@fibersystems.com](mailto:info@fibersystems.com).

### About Amphenol Fiber Systems International:

Amphenol Fiber Systems International (AFSI) designs, manufactures, markets and supports reliable and innovative fiber optic interconnect solutions that withstand the harsh environments of military, oil & gas, mining and broadcast applications. After more than two decades in business, AFSI continues to uphold its position as a global leader in fiber optic interconnect components and systems such as termini, M28876, MIL-ST, TFOCA and the TFOCA-II® connector, which AFSI developed and patented.

AFSI has delivered millions of fiber optic connectors in more than 34 countries. Whenever there is a need for superior, cost-effective fiber optic systems and products that will stand up to demanding operating environments, you can rely on AFSI for engineering know-how, top-quality products and expert technical support.

Visit [www.fibersystems.com](http://www.fibersystems.com) for more information.

**Patent Pending**

**Patent Pending**

**Amphenol Fiber Systems International, Inc.** | 1300 Central Expressway N, Suite 100 Allen, TX 75013

Phone: (214) 547-2400 | Email: [sales@fibersystems.com](mailto:sales@fibersystems.com) | Website: [www.fibersystems.com](http://www.fibersystems.com)

Amphenol Fiber Systems International (AFSI), a division of Amphenol Military & Aerospace Operations (AMAO), is the largest manufacturer of harsh environment fiber optic cable assemblies & connectors in the world. Visit AMAO at [amphenolmao.com](http://amphenolmao.com).